

**V-Twin Mfg.
 Replica Oil Tank Black
 VT No. 40-0473
 Measurement Guide**

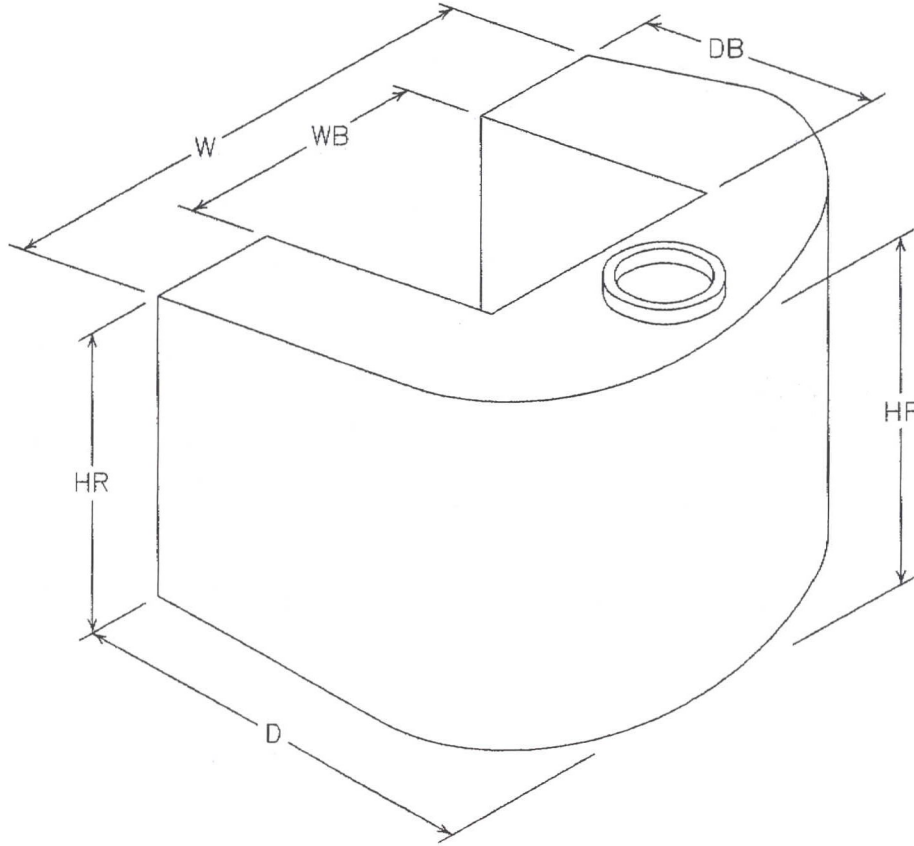

Tank Dimensions

Height of Front	HF	7"
Height of Rear	HR	6.5"
Depth	D	8.75"
Depth of Battery Box	DB	5"
Width	W	10"
Width of Battery Box	WB	4.875"